

ZANUSSI

BUILT-IN
DOUBLE OVEN
MODEL ZDM 869

INSTRUCTION BOOKLET

Please read this instruction booklet before using the oven

Important Safety Information



You MUST read these warnings carefully before installing or using the oven. If you need assistance, contact our Customer Care Department on 01635 521313

Installation

- This oven must be installed by qualified personnel to the relevant British Standards.
- This oven is heavy. Take care when moving it.
- Remove all packaging, both inside and outside the oven, before using the oven.
- Do not attempt to modify the oven in any way.

Child Safety

- This oven is designed to be operated by adults. Do not allow children to play near or with the oven.
- The oven gets hot when it is in use. Children should be kept away until it has cooled.

During Use

- This oven is intended for domestic cooking only. It is not designed for commercial or industrial purposes.
- Never line any part of the oven with aluminium foil.
- Do not allow heatproof cooking material, e.g. roasting bags, to come into contact with oven elements.
- Never place plastic or any other material which may melt in or on the oven.
- Do not place sealed cans or aerosols inside the oven. They may explode if they are heated.
- Do not hang towels, dishcloths or clothes from the oven or its handle.
- Do not use this oven if it is in contact with water and never operate it with wet hands.
- Take great care when heating fats and oils as they will ignite if they become too hot.
- Always use oven gloves to remove and replace food in the oven.

- Ensure that all control knobs are in the OFF position when not in use.
- Do not leave cookware containing foodstuffs, e.g. fat or oil in or on the oven in case it is inadvertently switched ON.
- When using other electrical appliances, ensure the cable does not come into contact with the hot surfaces of the oven.

Maintenance and Cleaning

- Only clean this oven in accordance with the instructions.
- The oven should be kept clean at all times. A build-up of fats or other foodstuffs could result in a fire, especially in the grill pan.
- Always allow the oven to cool down and switch off the electrical supply before carrying out any cleaning or maintenance work.

Service

- This oven should only be repaired or serviced by an authorised Service Engineer and only genuine approved spare parts should be used.

Environmental Information

- After installation, please dispose of the packaging with due regard to safety and the environment.
- When disposing of an old appliance, make it unusable, by cutting off the cable. Remove any door catches, to prevent small children being trapped inside.

Keep this instruction book for future reference and ensure it is passed on to any new owner.

Contents

For the User

Important safety information	Page 2
Description of the oven	Page 4
Controls	Page 5
The Clock / Electronic Timer	Page 7
Before the First Use	Page 9
Using the Oven	Page 9
Using the Conventional Oven	Page 11
Cooking Chart	Page 13
Using the Fan Oven	Page 14
Defrosting	Page 17
Grilling	Page 18
Using the Meat Probe	Page 21
Hints and Tips about Using the Lower Oven	Page 22
Cleaning the Oven	Page 23
Care of Catalytic Liners	Page 24
Cleaning the Hinged Grill	Page 26
What happens if something goes wrong	Page 27
Service and Spare Parts	Page 28
Peace of Mind for 24 months	Page 28

For the Installer

Technical Data	Page 29
Electrical Connection	Page 30
Installation	Page 31

Guide to Use the Instruction Book

The following symbols will be found in the text to guide you throughout the Instructions:



Safety Instructions



Step by step instructions for an operation



Hints and Tips



This appliance complies with the following **E.E.C. Directives**:

- * 73/23 - 90/683 (Low Voltage Directive);
 - * 93/68 (General Directives);
 - * 89/336 (Electromagnetical Compatibility Directive) .
- and subsequent modifications

Description of the Oven

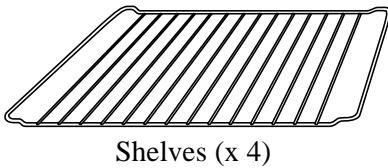
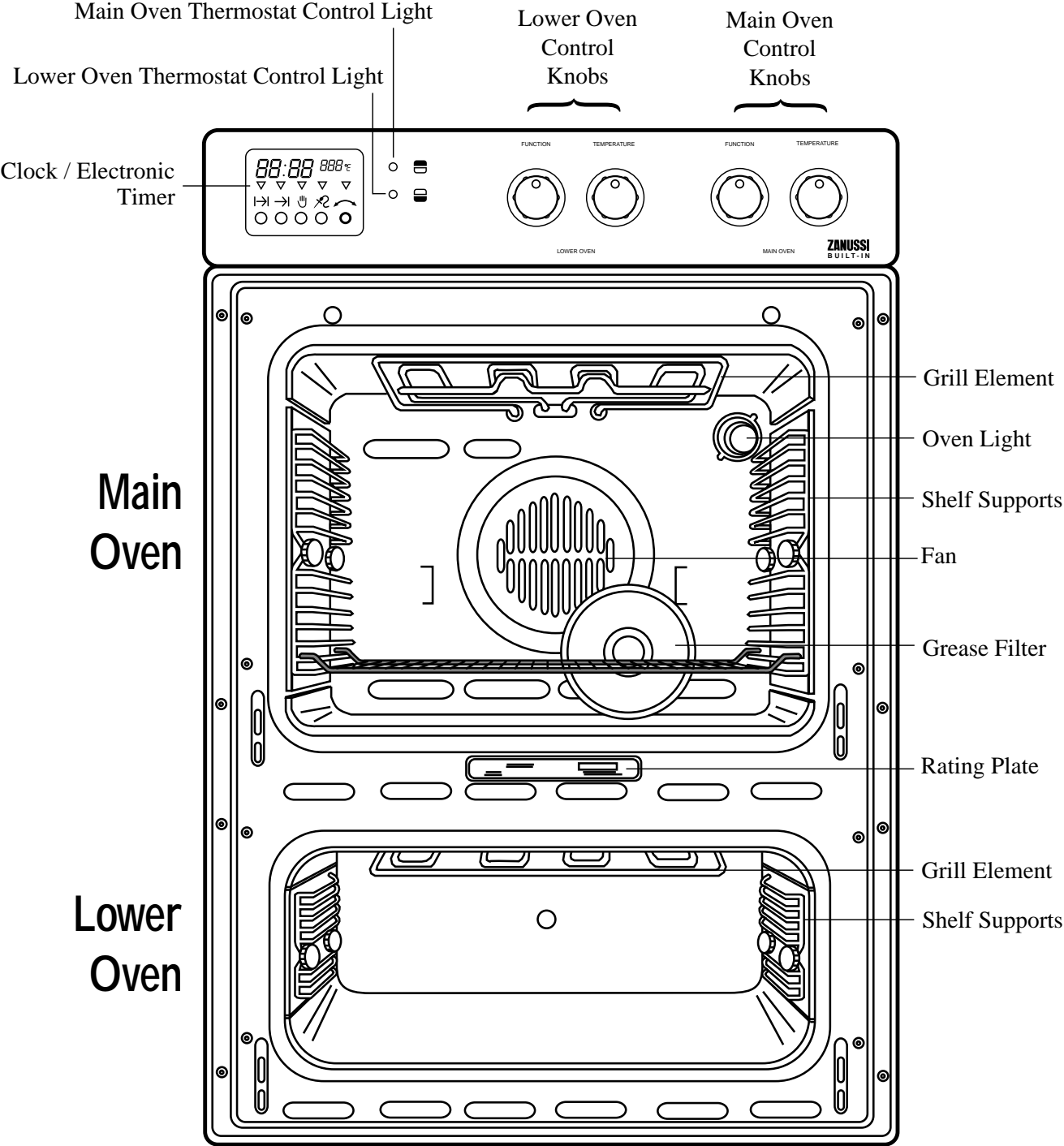



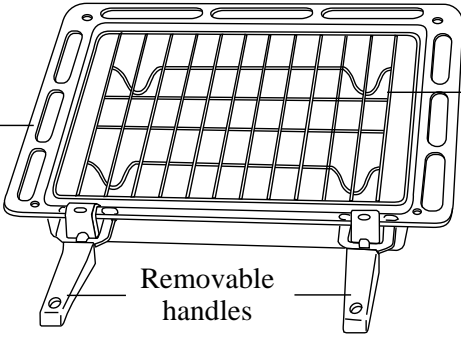





Grill/roasting pan



Controls

Main Oven

Oven Function Control Knob

-  Oven Light - The oven light will be on without any cooking function
-  Defrost Setting - This setting is intended to assist in thawing of frozen food (see page 17).
-  Conventional cooking - The heat comes from both the top and bottom element, ensuring even heating inside the oven.
-  Top heating element - The heat comes from the top of the oven only.
-  Bottom heating element - The heat comes from the bottom of the oven only.
-  Fan cooking - This allows you to roast or roast and bake simultaneously using any shelf, without flavour transference.
-  Inner grill element only - Can be used for grilling small quantities.
-  Full Grill - The full grill element will be on
-  Thermal Grilling - This function offers an alternative method of cooking food items, normally associated with conventional grilling. The grill element and the oven fan operate together, circulating hot air around the food.

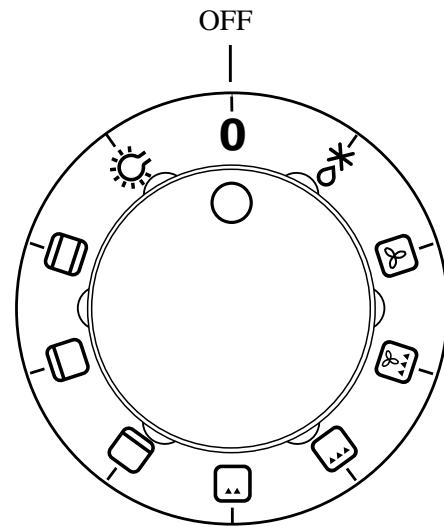



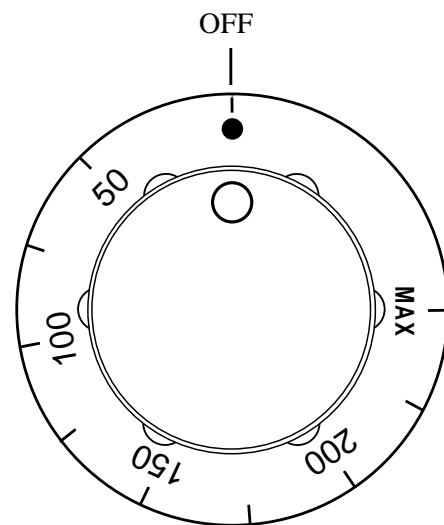

Thermostat Control Knob

Turn the thermostat control knob clockwise to select temperatures between 50°C and 250°C (MAX).



Lower Oven

Oven Function Control Knob

-  Conventional cooking - The heat comes from both the top and bottom element, ensuring even heating inside the oven.
-  Top heating element - The heat comes from the top of the oven only.
-  Bottom heating element - The heat comes from the bottom of the oven only.
-  Inner grill element only - Can be used for grilling small quantities.
-  Full Grill - The full grill element will be on

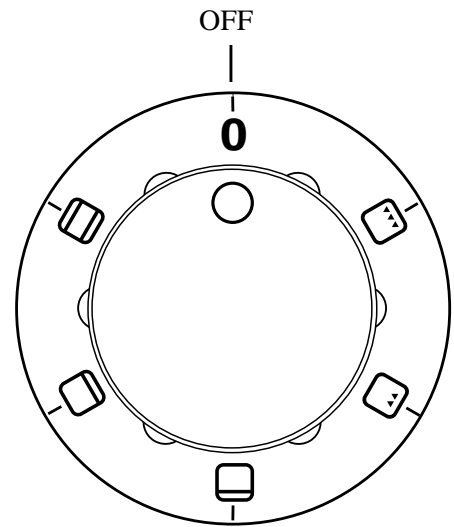



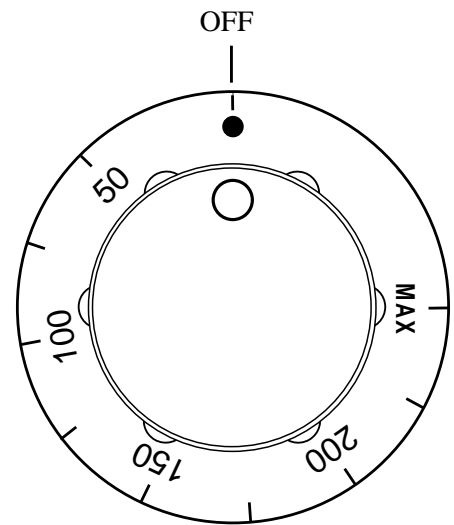

Thermostat Control Knob

Turn the thermostat control knob clockwise to select temperatures between 50°C and 250°C (MAX).



Electronic Timer

-  Cooking duration
-  End of cooking time
-  Manual function
-  Meat Probe
-  Time or temperature setting knob

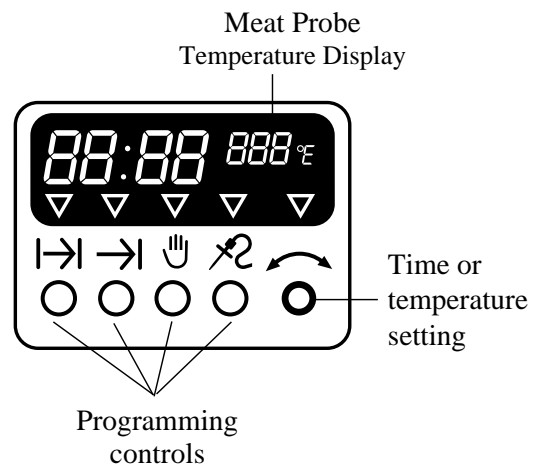

The Clock/Electronic Timer





The electronic timer can be used to programme the main oven only.

The electronic timer can indicate the time of day and automatically operate the main oven.

Before the oven can be operated, the time of day must be set on the electronic timer.



In case of loss of power, all the settings (time of day, program setting or program in operation), will be cancelled. When the power is restored, the numbers on the display will flash, and the timer has to be reset.

Please note that this is a 24 hour clock. For example, 2pm is shown as 14:00.

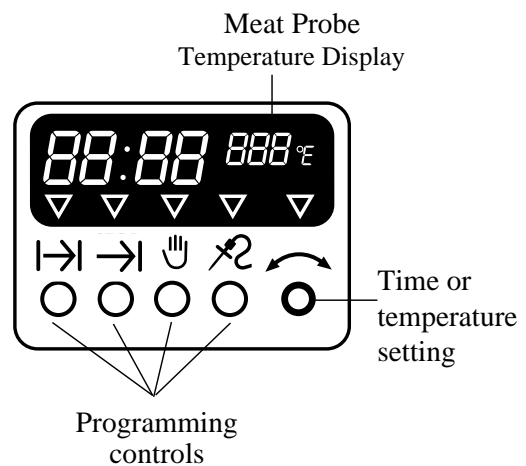
-  Cooking duration
-  End of cooking time
-  Manual function
-  Meat Probe



TO SET THE TIME OF DAY

Press buttons  and , and at the same time turn the time setting knob until the correct time of day is displayed.

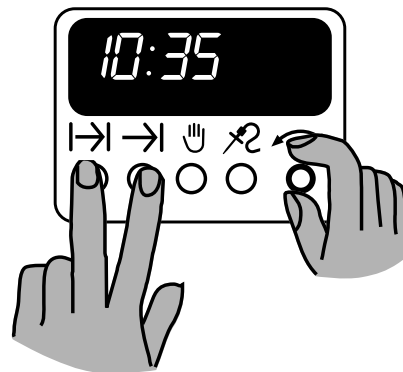

MANUAL FUNCTION

Press button  to set the oven for manual function.

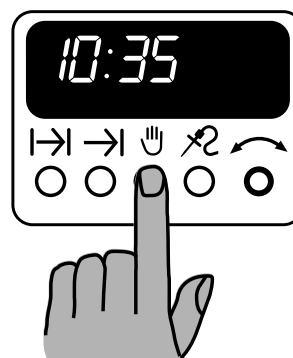

TO PROGRAMME THE OVEN TO SWITCH OFF ONLY

This is useful if you want to begin cooking immediately but have the oven switch off automatically.

1. Set the oven function control knob and the thermostat control knob on the required settings.
2. Place food in the oven.
3. Press button  and, at the same time, turn the time setting knob until the required cooking duration is displayed.

Our diagram shows the timer set for 30 minutes. At the end of the cooking time the oven will switch off and an alarm will sound. To switch off the alarm press button .

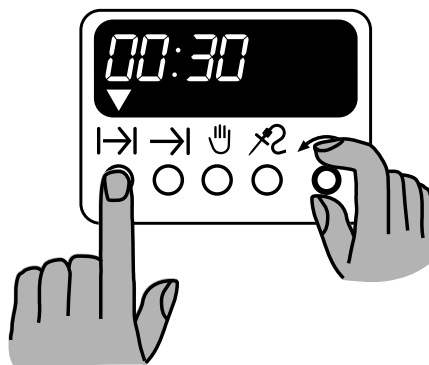

TO PROGRAMME THE OVEN TO SWITCH ON AND OFF

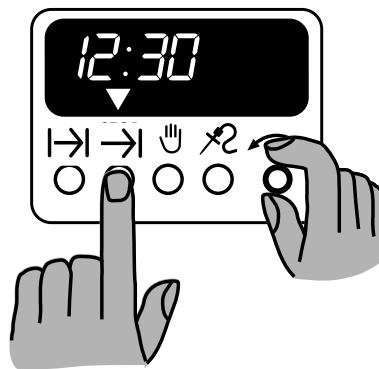

1. Ensure the clock is showing the right time of day.
2. Carry out steps 1, 2 and 3 as explained in "To programme the oven to switch off only".
3. Press button  and at the same time turn the time setting knob until the end cooking time is displayed.

Our diagram shows the end cooking time set for 30 minutes past noon. At the end of the cooking time the oven will switch off and an alarm will sound. To switch off the alarm press button .





TO SET THE TEMPERATURE FOR THE MEAT PROBE

Detailed instructions for this feature are given at page 21.

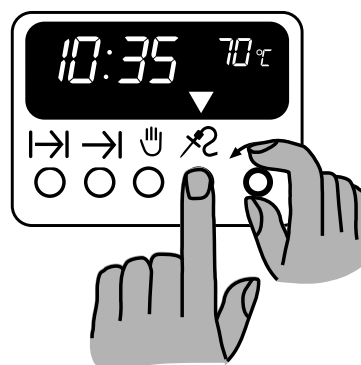
1. Insert the jack plug of the meat probe into the socket situated on the left hand side of the oven.
2. Insert the probe into meat and close the oven door.
3. Press button  and, at the same time, turn the temperature setting knob until the required temperature is displayed. Our diagram shows the meat probe temperature set for 70°C.
4. Set the oven function control knob and the thermostat control knob on the required settings.
5. When cooking is completed, an alarm will sound. To switch off the alarm press button .
6. **Remove the meat probe after use.**



TO CANCEL A PROGRAMME

1. Press button  and, at the same time, turn the time setting knob until the cooking duration is set on "zero".
3. If the end cooking time has been set too, press button  and at the same time turn the time setting knob until the end cooking time is set on "zero".

Before the First Use



Remove **all packaging**, both inside and outside the oven, before using the oven.

Before first use, the oven should be heated without food. During this time, an unpleasant odour may be emitted. This is quite normal.



1. Set the electronic timer to manual function.
2. Switch the main oven function control knob to conventional cooking
3. Set the thermostat control knob to MAX.
4. Open a window for ventilation.
5. Allow the oven to run empty for approximately 45 minutes.
6. Half way through, reset the oven function control to fan cooking

This procedure should be repeated with the grill

The lower oven should also be heated in the same way using both the conventional cooking function

Using the Oven



- **Always cook with the oven door closed.**
- Stand clear when opening the drop down oven door. **Do not** allow it to fall open - support the door using the door handle, until it is fully open.



- The Main Oven has fourteen shelf levels, and is supplied with two shelves. The Lower Oven has three shelf levels and is supplied with one shelf. The shelf positions are counted from the bottom of the oven as shown in the diagram. It is important that these shelves are correctly positioned as shown in the diagram.
- Do not place cookware directly on the oven base.

MAIN OVEN

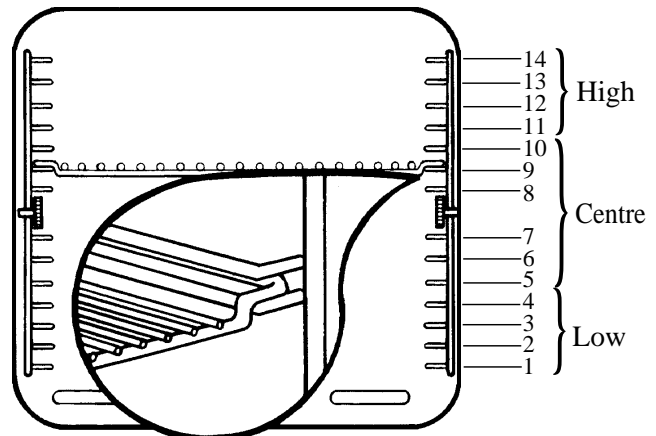

LOWER OVEN

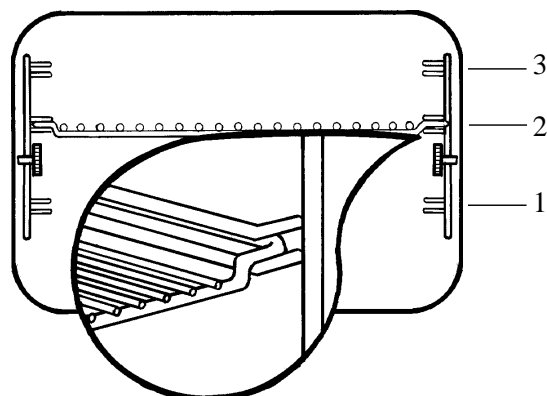

i Hints and Tips

Condensation and steam

When food is heated it produces steam in the same way as a boiling kettle. The oven vents allow some of this steam to escape. However, **always stand back from the oven when opening the oven door** to allow any build up of steam or heat to release.

If the steam comes into contact with a cool surface on the outside of the oven, e.g. a trim, it will condense and produce water droplets. This is quite normal and is not a fault with the oven.

To prevent discoloration, regularly wipe away condensation and also soilage from surfaces.

Cookware

- Use any oven proof cookware which will withstand temperatures of 250°C.
- Baking trays, oven dishes, etc. should not be placed directly against the grid covering the fan at the back of the oven, or placed on the oven base.
- Do not use baking trays larger than 30 cm x 35 cm (12 in x 14 in) as they will restrict the circulation of heat and may affect performance.

The effects of dishes on cooking results

Dishes and tins vary in their thickness, conductivity, colour, etc. which affects the way they transmit heat to the food inside them.

- A** Aluminium, earthenware, oven glassware and bright shiny utensils reduce cooking and underneath browning.
- B** Enamelled cast iron, anodized aluminium, aluminium with non-stick interior and coloured exterior and dark, heavy utensils increase cooking and underneath browning.

Using the Conventional Oven

When using this setting, heat comes from both the top and bottom elements. This allows you to cook on a single level and is particularly suitable for dishes which require extra base browning such as pizzas, quiches and flans.

Gratins, lasagnes and hotpots which require extra top browning also cook well in the conventional oven.

This form of cooking gives you the opportunity to cook without the fan in operation.

How to Use the Conventional Oven

1. Turn the oven function control knob to the required cooking function ().
2. Turn the thermostat control to the required temperature.

THINGS TO NOTE

- The oven light will come on when the oven function control knob is set.
- The thermostat control light will remain on until the correct temperature is reached. It will then cycle on and off to show that temperature is being maintained.

Top oven element only

This function is suitable for finishing cooked dishes, eg; lasagne, shepherds pie, cauliflower cheese etc.

Bottom oven element only

This function is particularly useful when blind-baking pastry or cooking pizza. It may also be used to finish off quiches or flans to ensure the base pastry is cooked through.

The Cooling Fan

- The cooling fan will operate continually during cooking. It may run on after the oven is switched off to keep the controls cool. This is quite normal.

NOTE

The action of the cooling fan will depend on how long the oven has been used and at what temperature. It may not switch in at all at lower temperature settings nor run on where the oven has only been used for a short time.

i Hints and Tips

The middle shelf position allows for the best heat distribution. To increase base browning simply lower the shelf position. To increase top browning, raise the shelf position.

The material and finish of the baking trays and dishes used will affect base browning. Enamelware, dark, heavy or non-stick utensils increase base browning, while oven glassware, shiny aluminium or polished steel trays reflect the heat away and give less base browning.

Always place dishes centrally on the shelf to ensure even browning.

Stand dishes on suitably sized baking trays to prevent spillage onto the base of the oven and make cleaning easier.

Do not place dishes, tins or baking trays directly on the oven base as it becomes very hot and damage will occur.

For faster preheating use the fan oven function to preheat the oven until the oven indicator neon goes out, then switch the selector to the conventional oven setting.

Single level cooking gives best results. If you require more than one level cooking use the fan oven function.

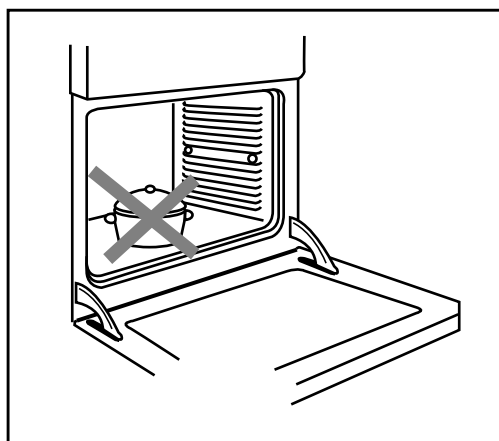
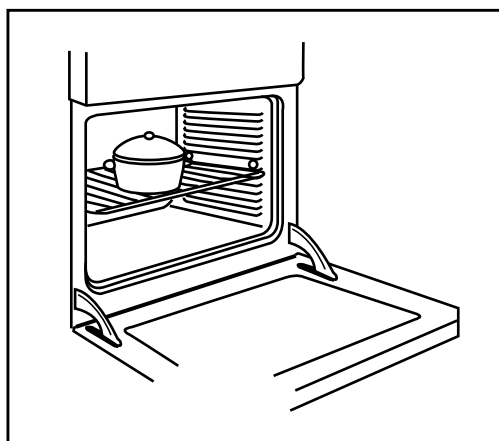

Cooking Chart - Conventional Oven

Food	Temperature (°C)	Runner Positions	Cooking Time (mins)
Biscuits	170-200	6 - 8	25-30
Bread, buns, yeast, doughs	200-230	5	35-45
Casseroles	140-170	3 - 5	90-180
Cakes - small, Queen Victoria sponge	170-190	5 - 7	18-25
Cakes - madeira, rich fruit	130-180	5	90-150
Choux pastry, eclairs	200-230	7	30-35
Fish	200-230	5 - 9	20-40
Fruit pies, plate tarts, crumbles	180-210	6	50-65
Meringues	90-100	6	90-150
Milk puddings	140-160	5	90-150
Pate, terrine (in baine-marie)	160-180	1 - 3	60-90
Pizzas	200-230	3 - 5	25-30
Puff pastry, sausage rolls, vol-au-vents	230-250	6	15-25
Quiches, flans	170-200	4 - 6	50-60
Scones	230-250	7 - 8	8-12
Souffle	200-230	6	35-45
Stuffed vegetables	230-250	6 - 8	35-45
Roast meat & poultry	180-200	6	see meat + poultry roasting chart
Yorkshire pudding	200-230	7 - 8	40-50
Keep food warm, heat dishes	90-100	6	

NOTE: Shelf positions are counted from bottom of the oven and are meant for the Main Oven only. When using the Lower Oven, please note that temperature and shelf positions must be adjusted according to type of food, its thickness and its weight.

Meat and Poultry Roasting Chart (Conventional Oven + Fan Oven)

Meat	Cooking Time
Beef	20-35 mins per 1/2kg (lb) + 20-35 mins
Beef, boned	25-35 mins per 1/2kg (lb) + 25-35 mins
Mutton and Lamb	25-35 mins per 1/2kg (lb) + 25-35 mins
Pork and Veal	30-40 mins per 1/2kg (lb) + 30-40 mins
Ham	30-40 mins per 1/2kg (lb) + 30-40 mins
Chicken	15-20 mins per 1/2kg (lb) + 20 mins
Turkey and Goose	15-20 mins per 1/2kg (lb) up to 3.5kg (7lb) + 15 mins per 1/2kg
Duck	25-35 mins per 1/2kg (lb) + 20 mins

When roasting, ensure the meat is cooked thoroughly, use a meat thermometer if preferred to check the centre temperature has reached the required temperature (see table below).

MEAT	TEMPERATURES
Beef	Rare - 60°C Medium - 70°C Well Done - 80°C
Pork	Well Done - 80°C
Lamb	Medium - 70°C Well Done - 80°C

Using the Fan Oven (Main Oven only)

The air inside the oven is heated by the element around the fan situated behind the back panel. The fan circulates hot air to maintain an even temperature inside the oven.

The advantages of cooking with this function are:

✓ **Faster Preheating**

As the fan oven quickly reaches temperature, it is not usually necessary to preheat the oven although you may find that you need to allow an extra 5-7 minutes on cooking times. For recipes which require higher temperatures, best results are achieved if the oven is preheated first, e.g. bread, pastries, scones, souffles, etc.

✓ **Lower Temperatures**

Fan oven cooking generally requires lower temperatures than conventional cooking. Follow the temperatures recommended in the chart at page. 15. Remember to reduce temperatures by about 20-25°C for your own recipes which use conventional cooking.

✓ **Even Heating for Baking**

The fan oven has uniform heating on all runner positions. This means that batches of the same food can be cooked in the oven at the same time. However, the top shelf may brown slightly quicker than the lower one.

This is quite usual. There is no mixing of flavours between dishes.

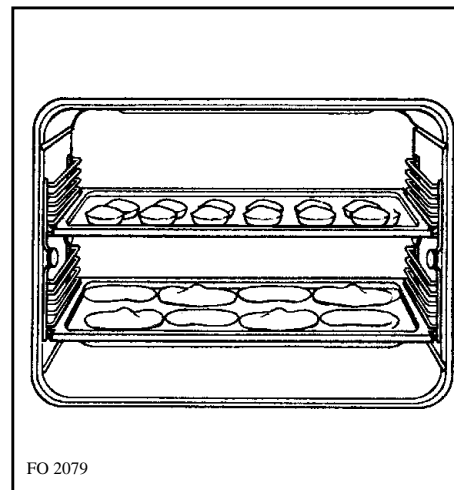

FO 2079

How to Use the Fan Oven

1. Turn the oven function control knob to .
2. Turn the thermostat control to the required temperature.

THINGS TO NOTE

During cooking, the cooling fan and the thermostat control light will operate in the same way as described for the conventional oven function.

Cooking Chart - Fan Oven

This chart is intended as a guide only. It may be necessary to increase or decrease the temperature to suit your individual requirements. Only experience will enable you to determine the correct setting for your personal requirements.

Food	Shelf Position	Cooking Temp (°C)	
Biscuits	Shelf positions are not critical but ensure that oven shelves are evenly spaced when more than one is used.	160-190	
Bread		190-220	
Casseroles		130-140	
Cakes: Small and queen		160-170	
Sponges		160-170	
Madeira		140-150	
Rich Fruit		130-140	
Christmas		130-140	
Meringues		90-100	
Fish		170-190	
Fruit Pies and Crumbles		170-200	
Milk Puddings		130-140	
Pastry: Choux		}	190-200
Shortcrust			
Flaky			
Puff			
Plate Tarts			180
Quiches/Flans		170-180	
Scones		210-220	
Roasting: Meat & Poultry		160-180	

When roasting, ensure the meat is cooked thoroughly, use a meat thermometer if preferred to check the centre temperature has reached the required temperature (see table below).

MEAT	TEMPERATURES
Beef	Rare - 60°C Medium - 70°C Well Done - 80°C
Pork	Well Done - 80°C
Lamb	Medium - 70°C Well Done - 80°C

i Hints and Tips

Runner positions are not critical, but make sure the shelves are evenly spread.

When cooking more than one dish in the fan oven, place dishes centrally on the shelves rather than several dishes on one shelf.

When the oven is full, you may need to allow slightly longer cooking time.

A shelf may be placed on the floor of the oven. Place dishes on a shelf in this position rather than on the oven base, to allow air circulation around the food.

When the oven is full of the same food, e.g. equal trays of small cakes or equal size victoria sandwich cakes, then they will be cooked in the same time and removed from the oven together. When different sizes of trays or types of food, e.g. biscuits and cakes are cooked, they will not necessarily be ready together.

The fan oven can be used to heat foods through without thawing first, e.g. fruit tarts, mince pies, sausage rolls, and other small pastry items. Use a temperature of 190-200°C and allow 20-40 minutes (depending on the quantity of food in the oven).

The use of too high temperatures can cause uneven browning. Check with the recommendations for oven temperatures given in the cooking charts, but be prepared to adjust the temperature by 10°C if necessary. Remember to reduce temperatures by about 20-25°C for your own conventional recipes.

When roasting do use the trivet in the meat tin. Fat and meat juices will drain into the meat tin below and can be used to make gravy. The trivet also prevents splashes of fat from soiling the oven interior.

The meat tin **should not** be placed on a heated hotplate or burner as this may cause the enamel to crack.

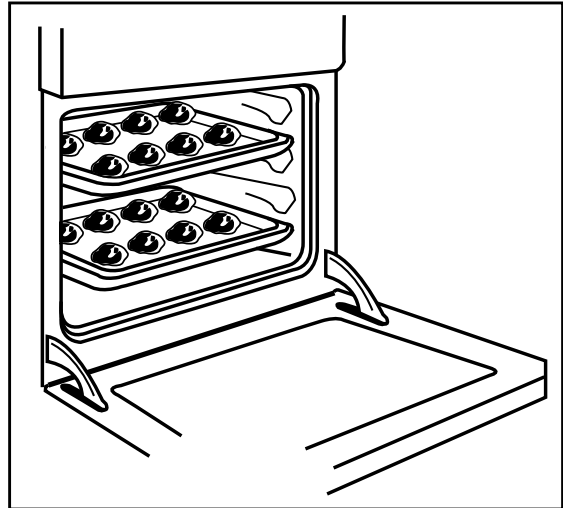

Defrosting (Main Oven only)

The oven fan operates without heat and circulates the air, at room temperature, inside the oven. This increases the speed of defrosting. However, please note that the temperature of the kitchen will influence the speed of defrosting.

This function is particularly suitable for delicate food which could be damaged by heat, e.g. cream filled gateaux, iced cakes, pastries, bread and other yeast products.

How to Use Defrosting

1. Turn the oven function control knob to .
2. Ensure the thermostat control knob is in the OFF position.

Hints and Tips

- Cover food with a lid, aluminium foil or plastic film to prevent drying out during defrosting.
- ALWAYS COOK THOROUGHLY IMMEDIATELY AFTER THAWING.
- Frozen food should be placed in a single layer when ever possible and turned over half way through the defrosting process.
- Only joints of meat and poultry up to 2 kg. (4 lb.) are suitable for defrosting in this way.

Refer to the following table for approximate defrosting times.

Food	Defrosting time (Mins)	Standing time (Mins)	Notes
Chicken 1000 g.	100-140	20-30	Place the chicken on an inverted saucer on a large plate. Defrost open and turn at half time or defrost covered with foil. Remove giblets as soon as possible.
Meat 1000 g.	100-140	20-30	Defrost open and turn at half time or cover with foil
Meat 500 g.	90-120	20-30	As above
Trout 150 g.	23-35	10-15	Defrost open
Strawberries 300 g.	30-40	10-20	Defrost open
Butter 250 g.	30-40	10-15	Defrost open
Cream 2 x 200 g.	80-100	10-15	Defrost open (cream is easy to whip even if parts of it are still slightly frozen)
Cake 1400 g.	60	60	Defrost open

The times quoted in the chart should be used as a guide only, as the speed of defrosting will depend on the kitchen temperature. For example, the colder the ambient temperature, the longer the defrosting time.

Grilling



 **Grilling must be carried out with the oven door closed. The grill pan handles must be removed from the pan.**

How to Use the Grill

1. Turn the oven control function knob to .
2. Turn the thermostat control knob on the required temperature.
3. Adjust the grid and grill pan runner position to allow for different thicknesses of food. Position the food close to the element for faster cooking and further away for more gentle cooking.

Preheat the grill on a full setting for a few minutes before sealing steaks or toasting. Adjust the heat setting and the shelf as necessary, during cooking

During cooking, the cooling fan and the thermostat control light will operate in the same way as described for the fan oven function.

Hints and Tips

- Most foods should be placed on the grid in the grill pan to allow maximum circulation of air to lift the food out of the fats and juices. Food such as fish, liver and kidneys may be placed directly on the grill pan, if preferred
- Food should be thoroughly dried before grilling to minimise splashing. Brush lean meats and fish lightly with a little oil or melted butter to keep them moist during cooking
- Accompaniments such as tomatoes and mushrooms may be placed underneath the grid when grilling meats
- When toasting bread, we suggest that the top runner position is used.
- The food should be turned over during cooking, as required.

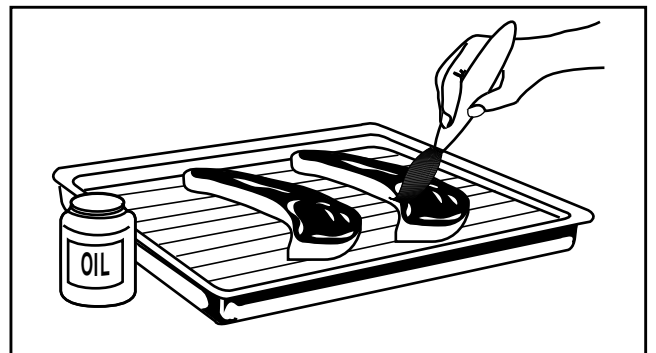

The grill element is controlled by the thermostat. During cooking, the grill cycles on and off to prevent overheating.

How to Use the Inner Grill Element

The inner grill provides quick direct heat to the central area of the grill pan. By using the inner grill element for cooking small quantities, it can help to save energy.

1. Turn the oven control function knob on .
2. Turn the thermostat control knob on the required temperature.
3. Adjust the grid and grill pan runner position to allow for different thicknesses of food and follow the instructions for grilling.

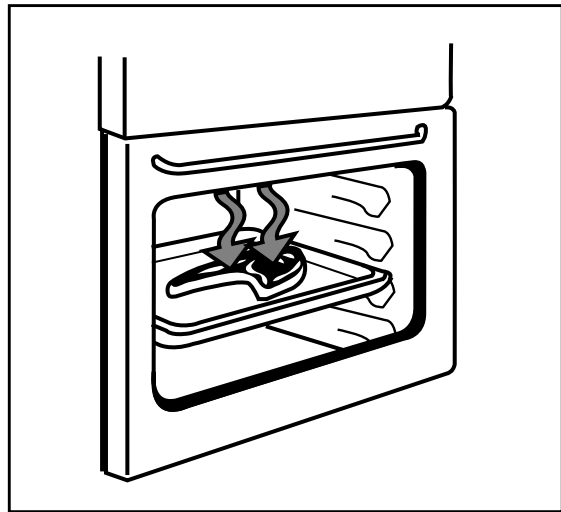

How to Use the Thermal Grill (Main Oven only)

Thermal grilling offers an alternative method of cooking food items normally associated with conventional grilling. The grill element and the oven fan operate alternately, circulating hot air around the food. The need to check and turn the food is reduced. Thermal grilling helps to minimize cooking smells in the kitchen.

With the exception of toast and rare steaks, you can thermally grill all the foods you would normally cook under a conventional grill. Cooking is more gentle, therefore food generally takes a little longer to cook with thermal grilling compared with conventional grilling. One of the advantages is that larger loads can be cooked at the same time.

1. Turn the oven control function knob on .
2. Turn the thermostat control knob on the required temperature. **Select a maximum temperature of 200°C.**
3. Adjust the grid and grill pan runner position to allow for different thicknesses of food and follow the instructions for grilling.

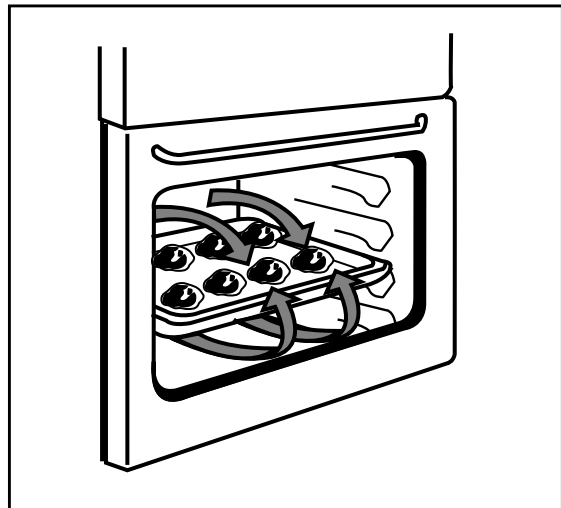

i Hints and Tips

Prepare foods in the same way as for conventional grilling. Brush lean meats and fish lightly with little oil or butter to keep them moist during cooking.

If thermally grilling on more than one level, it may be necessary to interchange the food on the shelves during cooking.

A general guide to cooking times is given below but these times may vary slightly depending on the thickness and quantity of food being cooked.

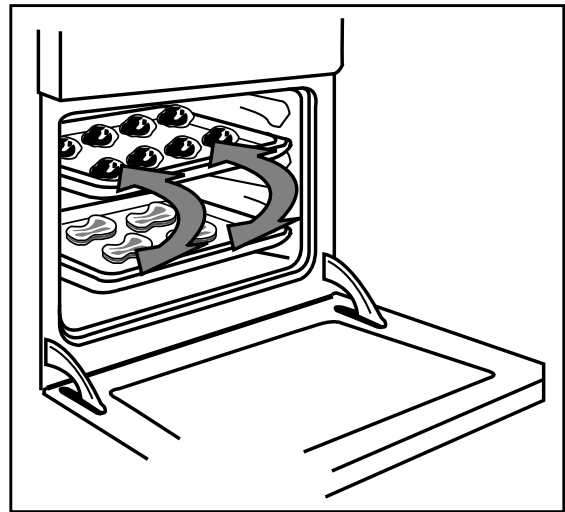

Cooking Chart - Grilling

FOOD	Grill and Inner Grill Element		Thermal Grill	
	Temp (°C)	Time (Mins per side)	Temp (°C)	Time (Mins)
Bacon Rashers	210	2-3	200	8-12
Beefburgers	200	6-10	190	10-15
Chicken Joints	170	10-15	160	35-45
Chops - Lamb	180	7-10	170	20-25
- Pork	180	10-15	170	25-35
Fish - Whole Trout/Herring	170	8-12	170	10-20
- Fillets Plaice/Cod	170	4-6	170	10-20
Kebabs	180	10-15	170	20-30
Kidneys - Lamb/Pig	170	4-6	180	10-15
Liver - Lamb/Pig	170	5-10	180	20-30
Sausages	180	10-15	190	10-15
Toast	250	1-2	--	
Heating through and Browning, e.g. au-gratin, lasagne, shepherd's pie.	-	-	170 depending on size	20-30 depending on size
Browning dishes only	230	3-5	--	



Using the Meat Probe (Main Oven only)

The meat probe is a feature which will control the cooking of meat by informing you of the exact temperature at the centre of the meat. It is not necessary to weigh the meat, the sensor determines the cooking time. However, the cooking time is obviously influenced by the cooking temperature. The probe consists of a skewer like sensor at one end of a heat resistant cable, and a plug at the other end.



Use only the meat probe supplied with the oven or an original spare part.

How to Use the Meat Probe

1. First raise the meat probe cover (1), which is located in the top of the left hand side of the oven and plug the probe connecting pin into its socket (2).
2. Insert the probe sensor into the centre of the meat, taking care to avoid touching any bone or pockets of fat as this will give a false temperature reading.
3. Place the meat, in a suitable tin, into the oven cavity.
As poultry is a difficult shape with a great deal of bone it is difficult to register a correct finish temperature, please ensure it is cooked thoroughly.
4. Then select the internal meat temperature (see roasting chart) by depressing button , and simultaneously turning the temperature setting dial until the correct temperature is displayed. Release the  button, a light above will illuminate to show that the programme has been accepted. The light and the temperature will be displayed in red.
5. Select the required cooking function and temperature.
6. When the selected temperature has been reached the digits in the display will start to flash and an audible signal will sound for two minutes.
7. Turn the oven and thermostat control knobs to the off position.
8. Open the oven door and remove the probe from the meat, then remove the probe from the socket and replace the safety plug. When the probe is removed from the display digits and cursor light go out and the oven automatically returns to manual operation.

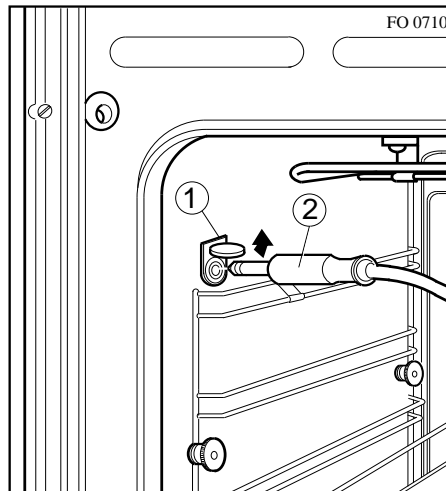

Roasting chart - Internal Temperatures

Pork	Well done	80°C
Lamb	Medium	70°C
	Well done	80°C
Beef	Rare	60°C
	Medium	70°C
	Well done	80°C
Chicken	Well done	82°C

The temperatures quoted above are given as a guide only.



Do not submerge the meat probe in water, just wipe with a clean damp cloth. Remove the meat probe after use. Do not leave the meat probe in the oven when cooking other items.

Hints and Tips about Using the Lower Oven

The lower oven is the smaller of the two ones. It is heated by two elements in the top and lower of the oven. It is designed for cooking smaller quantities of food. It gives especially good results if used to cook fruit cakes, sweet or savoury flans or quiche.

The lower oven is also ideal for use as a warming compartment to warm dishes and keep food hot. Use a temperature setting of 80°-100°C on the lower oven temperature control knob.

Things to note

1. The lower oven thermostat control light will glow until the oven has reached the desired temperature and then go out. It will cycle ON and OFF periodically during cooking showing that temperature is being maintained.
2. The control cooling fan will operate after a time.
3. The lower oven works independently of the top oven.

Hints and Tips

There should always be at least 2.5 cm (1") between the top of the food and the heating element. This gives the best cooking results and allows room for yeast mixtures to rise, Yorkshire puddings, etc.

When cooking cakes, pastry, scones, bread etc., place the tins or baking trays centrally below the element.

Ensure that food is placed centrally on the shelf and there is sufficient room around the baking tray/dish to allow for maximum circulation.

Stand dishes on suitable sized baking trays to prevent spillage onto the oven base and to help reduce cleaning.

The material and finish of the baking tray and dishes will affect the degree of base browning of the food. Enamelware, dark, heavy or non-stick utensils increase base browning. Shiny aluminium or polished steel trays reflect the heat away and give less base browning.

DO NOT use the grill pan or meat tin as a baking tray as this will increase base browning of the food.

Because of the smaller cooking space, lower temperatures and shorter cooking times are sometimes required.

For economy, leave the door open for the shortest possible time, particularly when placing food into a preheated oven.

Cleaning the Oven



Before cleaning always allow the cooling fan to cool the oven down before switching off at the electricity supply.

The oven should be kept clean at all times. A build-up of fats or other foodstuffs could result in a fire, especially in the grill pan.

Cleaning materials

Before using any cleaning materials on your oven, check that they are suitable and that their use is recommended by the manufacturer.

Cleaners that contain bleach should NOT be used as they may dull the surface finishes. Harsh abrasives should also be avoided.

External cleaning

Regularly wipe over the control panel, oven door and door seal using a soft cloth well wrung out in warm water to which a little liquid detergent has been added.



To prevent damaging or weakening the door glass panels avoid the use of the following:

- Household detergent and bleaches
- Impregnated pads unsuitable for non-stick saucepans
- Brillo/Ajax pads or steel wool pads
- Chemical oven pads or aerosols
- Rust removers
- Bath/Sink stain removers

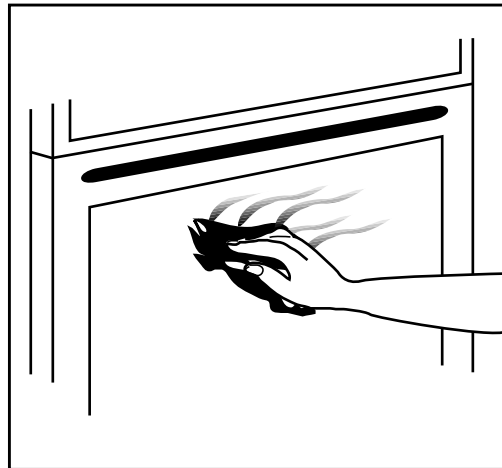

Clean the outer and inner door glass using warm soapy water. Should the inner door glass become heavily soiled it is recommended that a cleaning product such as Hob Brite is used. Do not use paint scrapers to remove soilage.



DO NOT clean the oven door while the glass panels are warm. If this precaution is not observed the glass panel may shatter.

If the door glass panel becomes chipped or has deep scratches, the glass will be weakened and must be replaced to prevent the possibility of the panel shattering. Contact your local Service Force Centre who will be pleased to advise further.

Oven Cavity

The enamelled base of the oven cavity is best cleaned whilst the oven is still warm.

Wipe the oven over with a soft cloth soaked in warm soapy water after each use. From time to time it will be necessary to do a more thorough cleaning, using a proprietary oven cleaner.

i DO NOT attempt to clean catalytic liners

Oven Shelves and Shelf Supports

To clean the oven shelves and the shelf supports, soak in warm soapy water and remove stubborn marks with a well wetted soap impregnated pad. Rinse well and dry with a soft cloth.

The shelf supports can be removed for easy cleaning (see diagram). Please, ensure the retaining nuts are secure when refitting the shelf support.

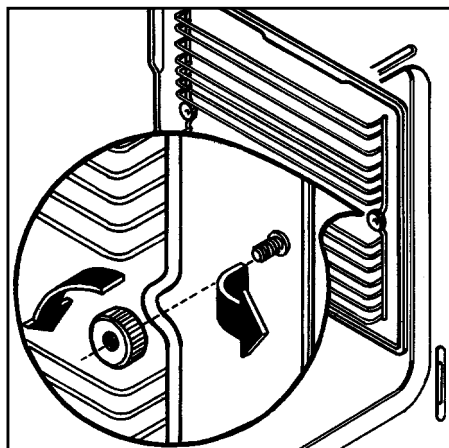

Grease Filter

To prevent a build-up of fats on the fan impellor, the grease filter must be fitted by clipping it over the vents in the back panel.

To clean the grease filter

When the oven has cooled down, remove the filter by pushing the protruding tongue on the filter upward, and wash carefully.

The grease filter should be cleaned after every use. The filter may be washed in a dishwasher on a 65°C wash. If the filter is heavily soiled, place the filter in a saucepan of water with approximately 1 teaspoon of automatic washing powder or dishwasher powder. Bring to the boil and leave to soak for approximately 30 minutes or longer depending on the degree of soiling. Ensure the solution does not boil over as it could mark your hob.

Rinse filter in clear water and dry.

Remember to refit the filter before using the oven again.

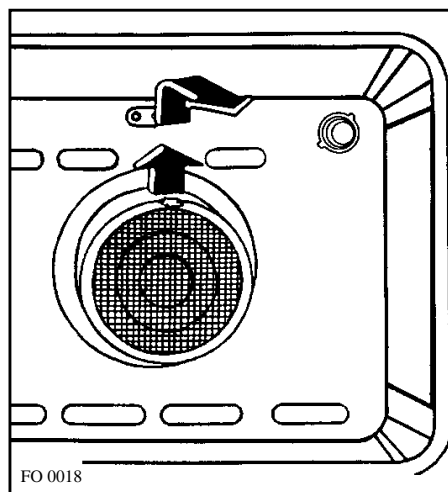

Care of catalytic liners (Main Oven only)

Catalytic liners destroy splashes of food and fats when the oven temperature is raised to around 220°C. To aid this process it is a good idea to run the oven for an hour or two per week, without food, to ensure continued good performance from the Catalytic liners.

Hints and Tips

- Manual cleaning of the Catalytic liner is not recommended. Damage will occur if soap impregnated steel wool pads, aerosol cleaners and any other abrasives are used.
- Slight discoloration and polishing of the Catalytic surface may occur in time. This does not affect the Catalytic properties in any way.
- Follow the recommendations below to keep oven soilage to a minimum.

COOKING TO REDUCE SOILAGE

Cook at the recommended temperatures. Higher temperatures during roasting will increase soilage. Try cooking to lower temperatures for an increased length of time, you will save energy and often the joint is more tender.

Use minimal, if any, extra oil or fat when roasting meat; potatoes only require brushing with fat before cooking. Extra fat in the oven during roasting will increase splashing and soilage.

It is NOT necessary to add water to the meat tin when roasting. The water and the fat juices from the joint create excessive splattering during cooking, even at normal temperatures, as well as causing condensation.

Covering joints during cooking will also prevent splashing onto the interior surfaces; removing the covering for the last 20-30 minutes will allow extra browning, if required. Some large joints and turkeys especially benefit by this method of cooking, allowing the joint to cook through before the outside is overbrowned.

Do use the roasting tin. During roasting, the fat from the joint will be contained beneath the trivet and therefore prevent it from splattering onto the 'Catalytic' liner.

Replacing the Oven Light

If the oven bulb needs replacing, it must comply with the following specifications:

- Electric power: 15W,
- Electric rate: 230-240 V (50 Hz),
- Resistant to temperatures of 300°C,
- Connection type: E14.

These bulbs are available from your local Zanussi Force Service Centre.

-  To replace the faulty bulb:
1. Ensure the oven is isolated from the electrical supply.
 2. Turn the glass cover anticlockwise.
 3. Remove the faulty bulb and replace with the new one.
 4. Refit the glass cover.
 5. Restore the electrical supply.

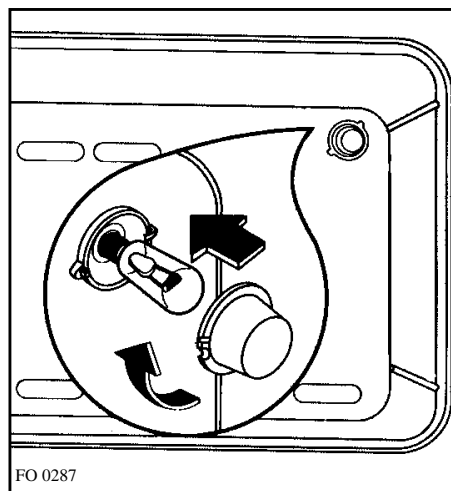

Cleaning the hinged grill

This model has been fitted with a hinged grill element to enable you to clean the roof of the oven easily.



Before proceeding ensure the oven is cool and is isolated from the electricity supply.



1) Undo the screw which holds the grill in place (see diagram).

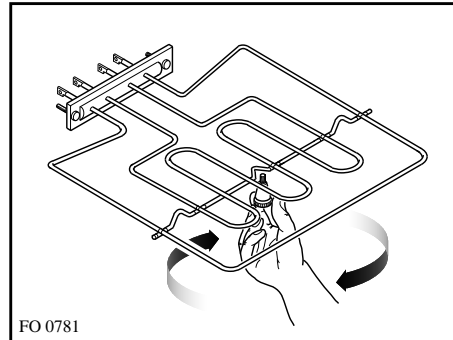

2) Then gently pull the grill downward to allow access to the oven roof (see diagram).

3) Clean the oven roof with a suitable cleaner and wipe dry before replacing the hinged grill element.

4) Gently push up the grill element into place and firmly screw into place the holding nut.

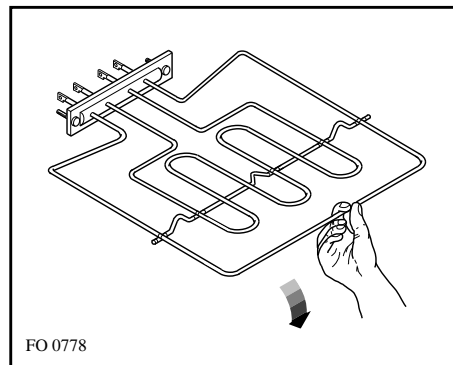

Ensure the grill holding nut is firmly in place to avoid the grill falling down when in use

If something goes wrong

If the oven is not working correctly, please carry out the following checks, before contacting your local Zanussi Service Centre.

IMPORTANT: If you call out an engineer to a fault listed below, or to repair a fault caused by incorrect use or installation, a charge will be made even if the appliance is under guarantee.

SYMPTOM	SOLUTION
<ul style="list-style-type: none"> ■ The oven does not come on 	<ul style="list-style-type: none"> ◆ Check the oven is in manual operation and that both a cooking function and temperature have been selected. ◆ Check the oven is wired in properly, and the socket switch or the switch from the mains supply to the oven are ON.
<ul style="list-style-type: none"> ■ The oven temperature light does not come on 	<ul style="list-style-type: none"> ◆ Select a temperature with the thermostat control knob ◆ Select a function with the oven function control knob.
<ul style="list-style-type: none"> ■ The oven light does not come on 	<ul style="list-style-type: none"> ◆ Select a function with the oven function control knob ◆ Check the light bulb, and replace it if necessary (see "Replacing the oven light")
<ul style="list-style-type: none"> ■ It takes too long to finish the dishes, or they are cooked too fast. 	<ul style="list-style-type: none"> ◆ The temperature may need adjusting ◆ Refer to the contents of this booklet, especially to the chapter "Using the Oven".
<ul style="list-style-type: none"> ■ Steam and condensation settle on the food and the oven cavity. 	<ul style="list-style-type: none"> ◆ Leave dishes inside the oven no longer than 15-20 minutes after the cooking is completed. See page 10
<ul style="list-style-type: none"> ■ The timer does not work 	<ul style="list-style-type: none"> ◆ Check the instructions for the timer.
<ul style="list-style-type: none"> ■ The oven fan is noisy 	<ul style="list-style-type: none"> ◆ Check the grease filter is correctly fitted. ◆ Check that shelves and bakeware are not vibrating in contact with the oven back panel.

If after all these checks, the oven still does not work, contact your local Zanussi Service Force Centre. When you contact them, they will need the following information:

1. Your name, address and post code.
2. Your telephone number
3. Clear and concise details of the fault
4. The model and the serial number (which can be found on the rating plate)
5. Date of purchase

Please note that it will be necessary to provide proof of purchase for any in-guarantee service calls.

In-guarantee customers should ensure that the above checks have been made as the engineer will make a charge if the fault is not a mechanical or electrical breakdown.

Service and Spare Parts



If you require spare parts or an engineer contact your local Service Force Centre by telephoning:

0990-929929

Your call will be routed to your local Service Force Centre. For further details, please see the accompanying Customer Care Booklet.

CUSTOMER CARE

For general enquiries concerning your Zanussi appliance, contact our Customer Care Department by letter or telephone as follows:

Customer Care Department

Zanussi House
Hambridge Road
Newbury, Berks, RG14 5EP
Tel: 01635 - 521313

Peace of Mind for 24 Months

ZANUSSI GUARANTEE CONDITIONS

We, Zanussi, undertake that if, within 24 months of the date of the purchase, this Zanussi appliance or any part thereof is proved to be defective by any reason only of faulty workmanship or materials, we will, at our option, repair or replace the same **FREE OF ANY CHARGE** for labour, materials or carriage on condition that:

- * The appliance has been correctly installed and used only on the gas and electricity supply stated on the rating plate.
- * The appliance has been used for normal domestic purpose only, and in accordance with the manufacturer's instructions.
- * The appliance has not been serviced, maintained, repaired, taken apart or tampered with by any person not authorised by us.
- * All service work under this guarantee must be undertaken by a Zanussi Service Centre.
- * Any appliance or defective part replaced shall become the Company's property.
- * This guarantee is in addition to your statutory and other legal rights.

Home visits are made between **8.30am and 5.30pm** Monday to Friday. Visits may be available outside these hours, in which case a **premium** will be charged.

Exclusions

This guarantee does not cover:

- * Damage or calls resulting from transportation, improper use or neglect, the replacement of any light bulbs or removable parts of glass or plastic.
- * Costs incurred for calls to put right an appliance which is improperly installed or calls to appliance outside the United Kingdom.

- * Appliances found to be in use within a commercial or similar environment, plus those which are the subject to rental agreements.
- * Products of Zanussi manufacture which are not marketed by Zanussi.

European Guarantee

If you should move to another country within Europe then your guarantee moves with you to your new home subject to the following qualifications:

- * The guarantee starts from the date you first purchased your product.
- * The guarantee is for the same period and to the same extent for labour and parts as exist in the new country of use for this brand or range of products.
- * This guarantee relates to you and cannot be transferred to another user.
- * Your new home is within the European Community (EC) or European Free Trade Area.
- * The product is installed and used in accordance with our instructions and is only used domestically, i.e. a normal household
- * The product is installed taking into account regulations in your new country.

Before you move, please contact your nearest Customer Care centre, listed below, to give them details of your new home. They will then ensure that the local Service Organisation is aware of your move and able to look after you and your appliances.

France	Senlis	+33 (0)3 44 62 29 99
Germany	Nürnberg	+49 (0)911 323 2600
Italy	Pordenone	+39 (0)1678 47053
Sweden	Stockholm	+46 (0)8 738 79 50
UK	Newbury	+44 (0)1635 521 313

Installation



The oven must be installed according to the instructions supplied.



*This oven must be installed by **qualified personnel** to the relevant British Standards.*

DIMENSIONS OF RECESS	Height	878 mm.
	Width	560-570 mm.
	Depth	550 mm.

DIMENSIONS OF THE MAIN OVEN CAVITY	Height	320 mm.
	Width	420 mm.
	Depth	390 mm.
	Oven capacity	53.2 litres

DIMENSIONS OF THE LOWER OVEN CAVITY	Height	185 mm.
	Width	420 mm.
	Depth	400 mm.
	Oven capacity	31 litres

Upper oven ratings

Oven element	1.89 kW
Top element	0.834 kW
Bottom element	1.055 kW
Convection element	2.08 kW
Grill element	1.82 kW
Double Grill element	2.655 kW
Convection Fan	30 W
Oven Light	15 W
Cooling Fan	25 W
Total Rating	2.695 kW

Lower oven ratings

Oven element	1.89 kW
Top element	0.834 kW
Grill element	1.82 kW
Double Grill element	2.655 kW
Oven Light	15 W
Total Rating	2.695 kW
Total connected load	5.365 kW

Electrical Connection

The oven is designed to be connected to 230-240V (50Hz) electricity supply.

The oven has an easily accessible terminal block which is marked as follows:

- Letter L - Live terminal
- Letter N - Neutral terminal
-  or E - Earth terminal

THIS OVEN MUST BE EARTHED

The cable used to connect the oven to the electrical supply must comply to the specifications given below.

For Uk use only

Connection via	Min. size Cable/flex	Cable / flex type	Fuse
• Cooker Control Circuit	6 mm ²	PVC/PVC twin and earth	30 A

For Europe use only

Min. size Cable/flex	Cable / flex type	Fuse
4 mm ²	H05 RR-F	30 A

It is necessary that you install a double pole switch between the oven and the electricity supply (mains), with a minimum gap of 3mm between the switch contacts and of a type suitable for the required load in compliance with the current rules.

The switch must not break the yellow and green earth cable at any point.

Important

After installation and connecting, the cable must be placed so that it cannot at any point reach a temperature of more than 60°C above the ambient temperature.

Before the oven is connected, check that the main fuse and the domestic installation can support the load; and that the power supply is properly earthed.

The manufacturer disclaims any responsibility should these safety measures not be carried out.

Building In



The oven must be installed according to the instructions supplied. Any electrical work must be undertaken by a qualified electrician/competent person, in accordance with existing rules and regulations.

It is dangerous to alter the specifications or modify the oven in any way.

Please ensure that when the oven is installed it is easily accessible for the engineer in the event of a breakdown.

BUILDING IN

The surround or cabinet into which the oven will be built must comply with these specifications:

- the dimensions must be as shown in the relevant diagrams;
- the materials must withstand a temperature increase of at least 60°C above ambient;
- proper arrangements must be made of a continuous supply of air to the oven to prevent the oven overheating.

Securing The Oven To The Cabinet

1. Fit the oven into the cabinet recess,
2. Open the oven door
3. Secure the oven to the kitchen cabinet with four wood screws, which fit the holes provided in the oven frame.

